

DKG-507 AUTOMATIC MAINS FAILURE UNIT

DESCRIPTION

The DKG-507 is a comprehensive AMF unit for a single generating set operating in standby mode.

In AUTOMATIC position, DKG-507 monitors mains phase voltages and controls the automatic starting, stopping and load transfer of the generating set in case of a mains failure and once the generator is running, it monitors internal protections and external fault inputs. If a fault condition occurs, the unit shuts down the engine automatically and indicates the failure source with the corresponding red led lamp.

The operation of the unit is controlled with front panel pushbuttons. The LOAD TEST, TEST, AUTO and OFF pushbuttons select the operating mode. Other buttons select the display parameter scroll, alarm mute and lamp test functions.

The DKG-507 provides a comprehensive set of digitally adjustable timers, threshold levels, input and output configurations and operating sequences. The unauthorized access to program parameters is prevented by the program lock input. All programs may be modified via front panel pushbuttons, and do not require an external unit.

The fault conditions are considered in 2 categories as Warnings and Alarms. Measured values have separate programmable limits for warning and alarm conditions.

The service request indicator lamp turns on at the expiration of either engine hours or time limits.

It is possible to monitor the operation of the system locally or remotely with the WINDOWS based PC utility program.

The unit is designed for front panel mounting. It is fitted into the cut-out with the steel spring removed. Connections are made with 2 part plug and socket connectors.

MEASUREMENTS

Generator Volts: U-N, V-N, W-N
 Generator Volts: U-V, V-W, W-U
 Generator Amps: U, V, W
 Generator total KW
 Generator pf
 Generator Frequency,
 Mains Volts: R-N, S-N, T-N
 Mains Volts: R-S, S-T, T-R
 Battery Voltage
 Engine Coolant Temperature
 Engine Oil Pressure
 Fuel Level

STATISTICS

Following incremental counters provide statistics about past performance of the generating set:
 Engine Hours Run
 Engine Hours to Service
 Time to Service
 Number of Engine Cranks
 Number of Genset Runs
 Number of Genset on Load

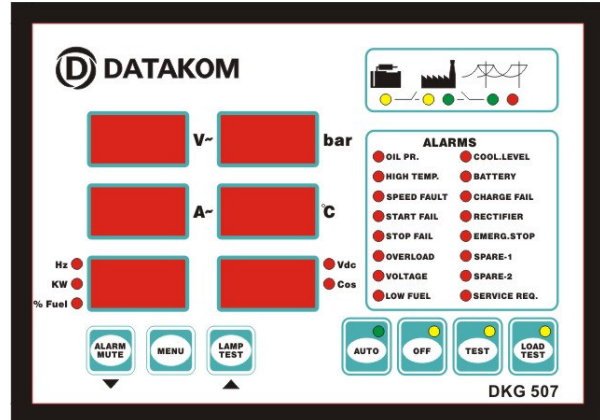

FEATURES

- Automatic mains failure**
- Engine control**
- Generator protection**
- Built in alarms and warnings**
- 3 phase mains voltage inputs**
- 3 phase genset voltage inputs**
- 3 phase genset CT inputs**
- Engine oil pressure measurement**
- Engine coolant temperature measurement**
- Fuel level measurement**
- Genset active power measurement**
- Genset power factor measurement**
- Periodic maintenance request indicator**
- Daily / weekly / monthly exerciser**
- Event logging with time stamp**
- Statistical counters**
- Battery backed-up real time clock**
- Weekly operation schedule programs**
- Field adjustable parameters**
- RS-232 serial port**
- Free MS-Windows Remote monitoring SW:**
 - local, LAN, IP and modem connection
 - monitoring, download of parameters
- LED displays**
- Configurable analogue inputs: 2**
- Configurable digital inputs: 7**
- Configurable relay outputs: 2**
- Total relay outputs: 6**
- I/O expansion capability**
- Remote Start operation available**
- Survives cranking dropouts**
- Sealed front panel**
- Plug-in connection system for easy replacement**
- Small dimensions (180x125x48mm)**
- Low cost**

EVENT LOGGING

The DKG-507 records last 12 events with date and time stamp. Recorded events are:

- alarms and warnings
- generator on-load/off-load information

Event records are only displayed on the PC screen.

WEEKLY OPERATION SCHEDULE

In AUTO mode only, the unit offers the capability of defining a weekly operation schedule. Programmable parameters allow the genset to operate automatically only in defined time limits of each weekday.

The internal battery backed-up real time clock allows precise switching times.

DIGITAL INPUTS

The unit has 7 configurable digital inputs. Each input has following programmable parameters:

- alarm type: shutdown / warning / no alarm
- alarm polling: on engine running / always / on mains OK
- latching / non-latching operation,
- contact type: NO / NC
- switching: BAT+ / BAT-

ANALOG INPUTS

Engine analog inputs are provided for following functions:

- Coolant temperature
- Oil pressure
- Fuel level

The analog inputs connect to resistive sender units to provide precise and adjustable protection. The coolant temperature and oil pressure inputs have programmable sensor characteristics so that they are suitable for any type and any brand of sensors.

RELAY OUTPUTS

The unit provides 6 relay outputs and 2 of them have programmable functions, selectable from a list.

In addition to genset control signals any specific alarm information may be output as a relay contact.

Using two Relay Expansion Modules, the number of relays may be increased up to 22, 16 of them being volt-free contacts.

TELEMETRY AND REMOTE PROGRAMMING

The DKG-507 module provides the user with large telemetry facilities via its standard RS-232 serial port. The unit can be either connected to a PC or a modem for remote communication. The PC software offers local, Local Area Network (LAN), internet and modem operation capabilities. Note that the modem mode is also compatible with LAN and internet modes, so that the modem data may be served by PC for reuse in the LAN or internet.

The PC program is used for below purposes:

- parameter upload/download
- remote monitoring
- diagnostics and analysis

The PC software detects automatically new versions over the internet. A menu system will guide the user if he desires to download the new version.

TECHNICAL SPECIFICATIONS

Alternator voltage: 15-300 V-AC (Ph-N)

Alternator frequency: 0-100 Hz.

Mains voltage: 300 V-AC max. (Ph-N)

Mains frequency: 50/60 Hz.

DC Supply Range: 9.0 to 33.0 V-DC

Cranking dropouts: survives 0 V for 100ms.

Typical Standby Current: 100 mA-DC

Maximum Operating Current: 350 mA-DC (Relay outputs open)

Generator Contactor Relay Output: 16 A / 250V

Mains Contactor Relay Output: 16 A / 250V

DC Relay Outputs: 10 A / 28V

Charge excitation current: 54mA @ 12V-DC.

Analog input range: 0-5000 ohms.

Serial port: RS-232, 2400 bauds, no parity, 1 bit stop

Operating temp.: -20°C (-4°F) to 70 °C (158°F).

Storage temp.: -30°C (-22°F) to 80 °C (176°F).

Maximum humidity: 95% non-condensing.

IP Protection: IP65 from front panel, IP30 from the rear.

Dimensions: 190 x 135 x 48 mm (WxHxD)

Panel Cut-out Dimensions: 176x121 mm minimum.

Mounting: Front panel mounted with rear retaining steel spring.

Weight: 460 g (approx.)

Case Material: High Temperature ABS (UL94-V0, 110°C)

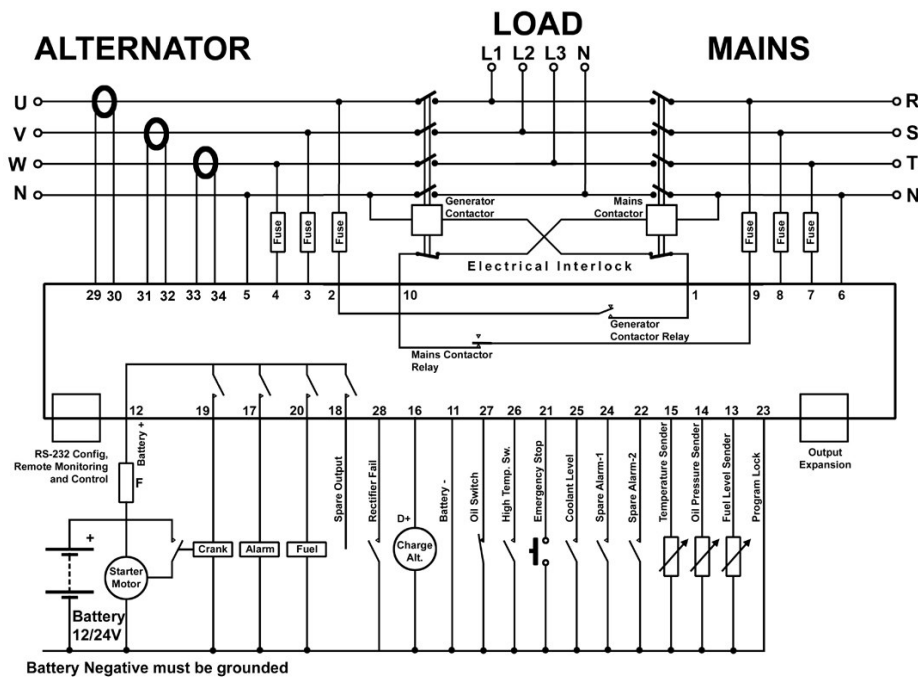

DATAKOM Electronics Ltd.

Tel : +90-216-466 84 60

Fax : +90-216-364 65 65

<http://www.datakom.com.tr>

e-mail : datakom@datakom.com.tr